

ASHLEY 42"

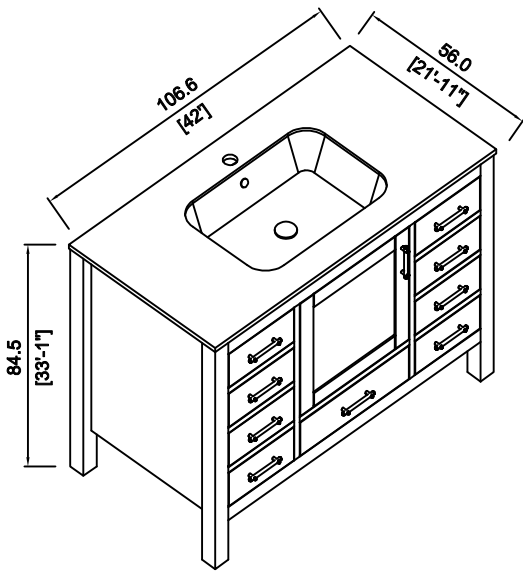

ISOMETRIC VIEW

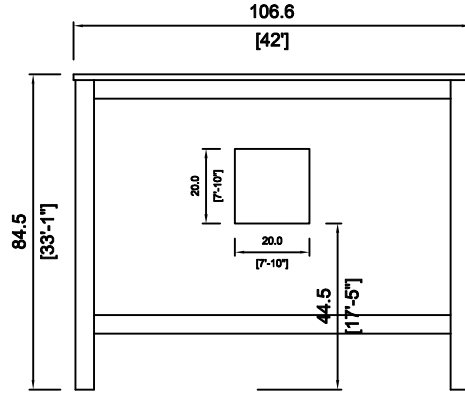

BACK VIEW

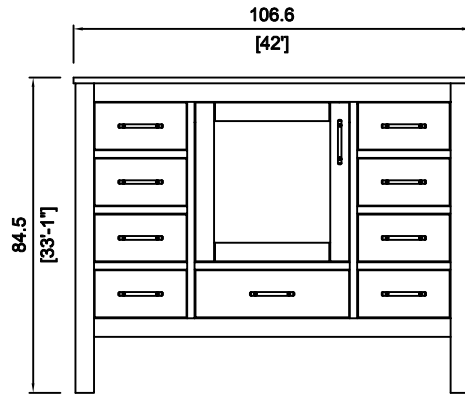

FRONT VIEW

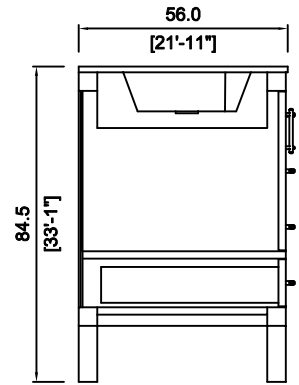

SIDE SECTION

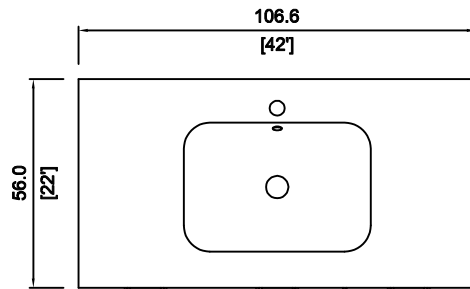

PLAN VIEW

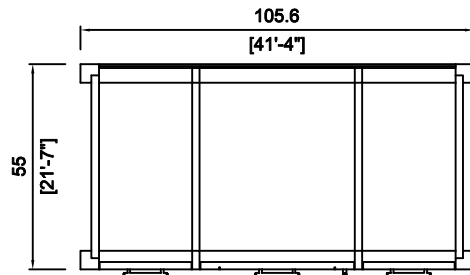

PLAN SECTION